

一個滑塊含4個滾輪軸承

LGD-8A/ LGD-8L

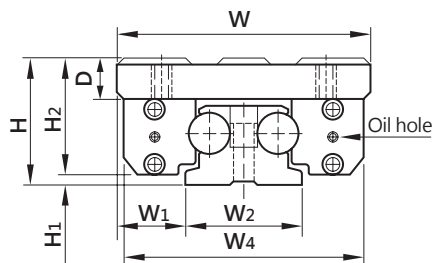

**LGD-12A/ LGD-12L
LGD-16A/ LGD-16L**

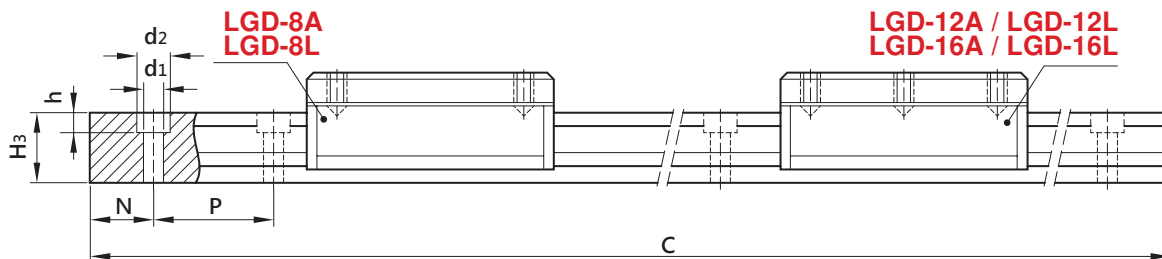
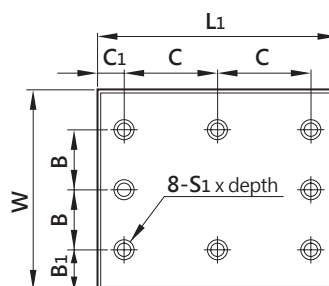
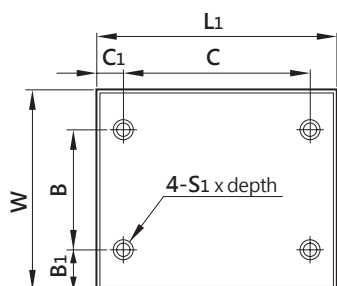
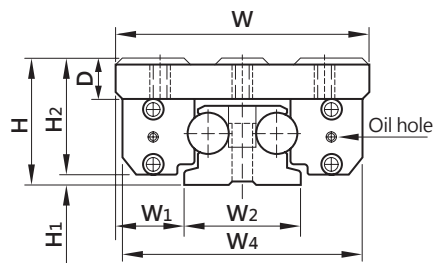

單位: mm

型號	軸徑	組合尺寸			滑塊尺寸									軌道尺寸							基本動 定格 荷重 C (kgf)	基本靜 定格 荷重 Co (kgf)	容許靜力距				
		H	H1	W1	W	W4	H2	D	L1	B	B1	C	C1	S1	W2	H3	d1	d2	h	P			N	L(max)	To	Tx	Ty
LGD-8A	8	30	3.5	16	60	59	26	9	70	40	10	50	10	M6x9	28	20	5.7	10.4	5.2	50	25	3,000	80	130	3.6	3.0	3.2
LGD-8L									100																80	5.5	
LGD-12A	12	40	4.0	23	82	80	36	12	100	27	14	38	12	M6x12	36	25	6.8	12.6	6.2	50	25	4,000	180	290	5.4	4.0	4.8
LGD-12L									140			58													8.5		
LGD-16A	16	50	5.0	35	120	118	45	14	150	45	15	60	15	M8x16	50	32	9.0	21.0	8.0	80	40	4,000	330	530	13.5	19.8	21.6
LGD-16L									190			80													38.2		

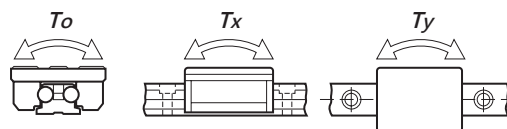
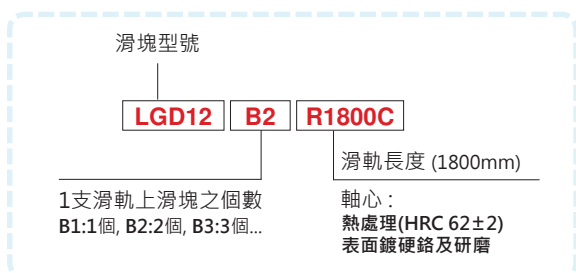

經濟型 ECONOMICAL TYPE

一個滑塊含4個滾輪軸承

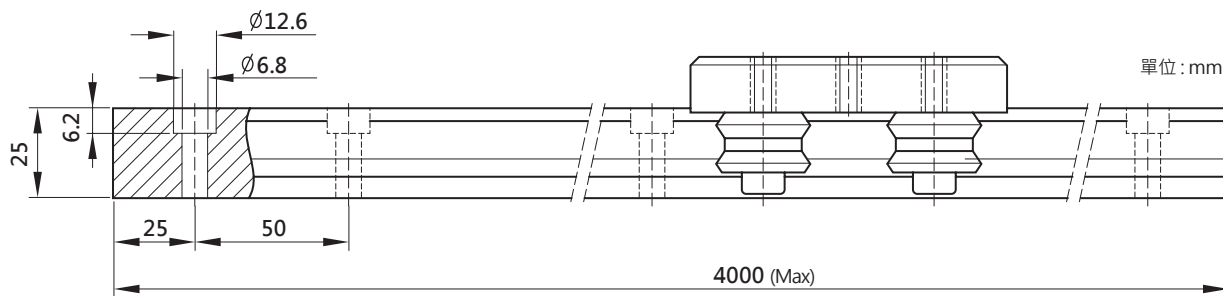
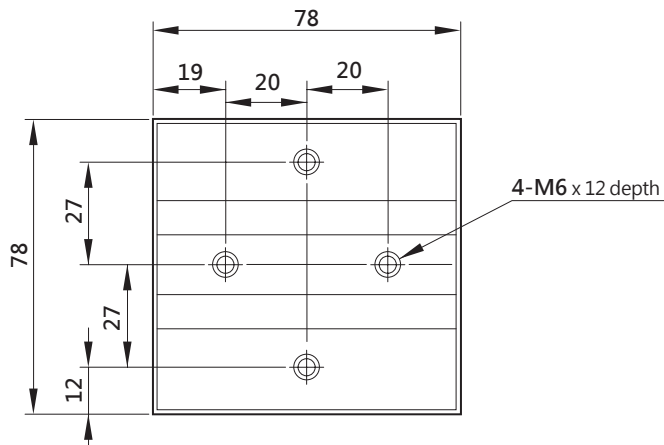
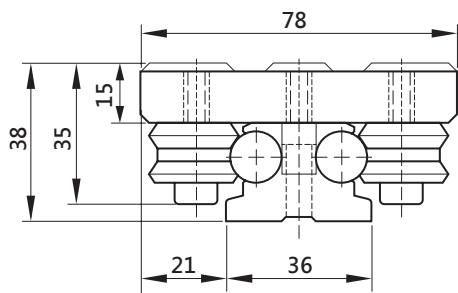
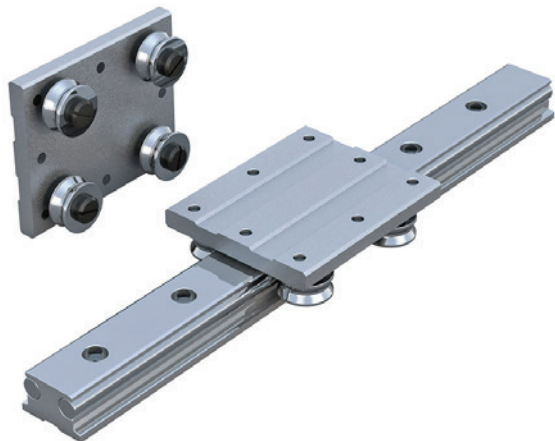

滑塊型號

LGD12E **B2** **R1800C**

1支滑軌上滑塊之個數
B1:1個, B2:2個, B3:3個...

滑軌長度 (1800mm)

軸心:
熱處理(HRC 62±2)
表面鍍硬鉻及研磨

基本動定格 荷重 C (kgf)	基本靜定格 荷重 Co (kgf)	容許靜力距			重量	
		To kgf-m	Tx kgf-m	Ty kgf-m	滑塊 kg	軌道 kg/m
140	230	4.3	3.2	3.8	0.36	3.2

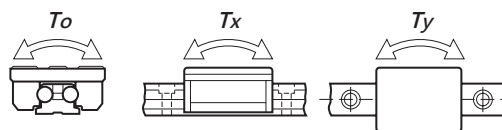

荷重型 HEAVY LOAD TYPE

一個滑塊含8個滾輪軸承

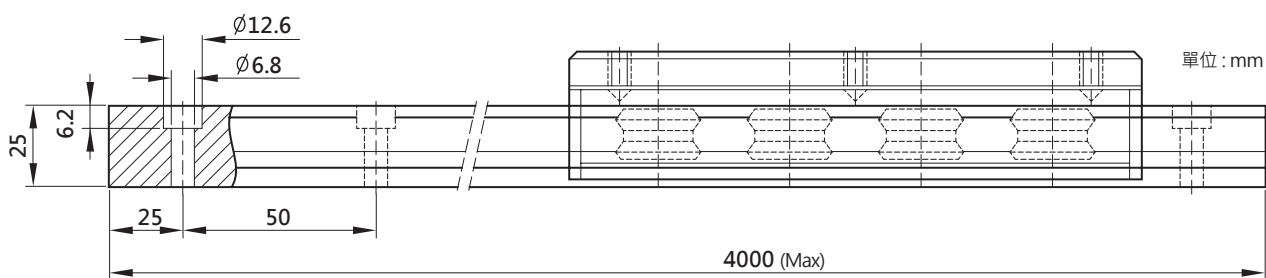
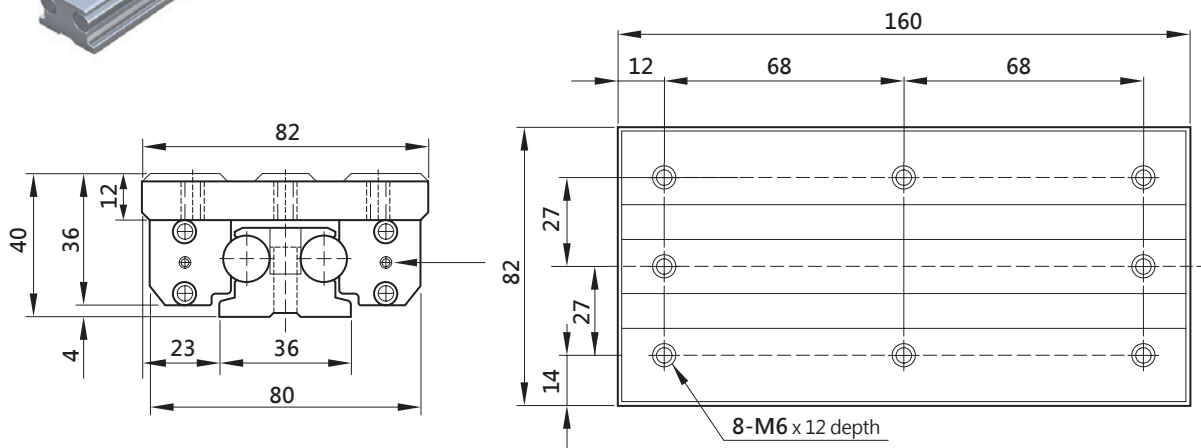
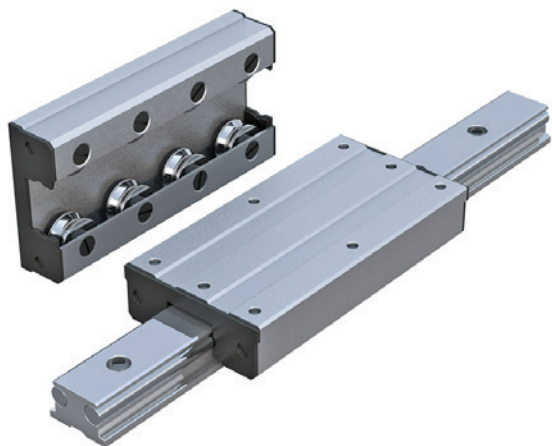

滑塊型號

LGD12XL **B2** **R1800C**

滑軌長度 (1800mm)

1支滑軌上滑塊之個數
B1:1個, B2:2個, B3:3個...

軸心:
熱處理(HRC 62±2)
表面鍍硬鉻及研磨

基本動定格 荷重 C (kgf)	基本靜定格 荷重 Co (kgf)	容許靜力距			重量	
		T_o kgf-m	T_x kgf-m	T_y kgf-m	滑塊 kg	軌道 kg/m
290	460	8.7	11.2	13.6	0.86	3.2

